

Bubbler Classic Pro 4x9 lt, R290



**Ref: CC0H5A
(SR4E22290FEUSPM)**

Cold beverage dispenser - Classic Pro 4x9 lt, with new easy-off release bowl and high efficiency cooling system

General Features

CLASSIC PRO 4x9 is a cold drink premix dispenser, compact size, with 4x9 liters capacity tanks.

The machine cools and dispenses ready-made drinks to be poured inside the bowl such as fresh juices, teas, cocktails, flavored water etc..

The unique evaporator and the high efficiency system cool faster and more efficiently for a quick start-up.

The superior engineering ensures a perfect temperature from the first to the last drop of dispensed product.

Two-piece dripless pouring valves are easy to use and clean. Suitable for cups up to 9 inch height (22,9 cm).

New easy-off release bowl system, that makes dismantle easier and reduces cleaning time.

Drinks stirring by a magnetic submerged impeller. Agitators are provided with each unit.

Panels are in stainless steel.

OPTIONALS AVAILABLE:

- VALVE CAP: improves sealing of valve when using pulpy product
- FOUNTAIN SPRAY KIT: ideal to create a spectacular effect
- EXCLUSIVE AUTOFILL LID: retrofittable postmix autofill system that increase consistency and exclude manual filling operations.

Bubbler Classic Pro 4x9 lt, R290

Specifications

- Suitable for cups up to 8 inch height (20 cm)
- Easy-off bowl release system for faster and easier assembly and disassembly.
- User friendly design enables machine to dispense product till the very last drop.
- Agitation function, with low foam impeller cover special for fresh juices, coffees, vitamin water or tea.
- Appealing cold drink dispenser equipped with 4 bowls, 9 litres each

Construction

- Magnetic submerged impeller
- Refrigerant type: R290.
- Pre-mix dispenser with stainless steel base and clear plastic bowls.
- The air intakes from the bottom and exhaust to back.

Bubbler Classic Pro 4x9 lt, R290

Electric

Supply voltage:	220-240 V / 1N ph / 50/60 Hz
Electrical power max.:	0.6 kW
Current consumption:	2.5 Amps
Plug type:	CE-SCHUKO

Key Information:

Number of bowls:	4
Bowl's capacity:	9 lt
Dimensions, Width:	520 mm
Dimensions, Depth:	450 mm
Dimensions, Height:	790 mm
Net weight:	41.8 kg

Refrigeration Data

Refrigerant gas:	R290
------------------	------

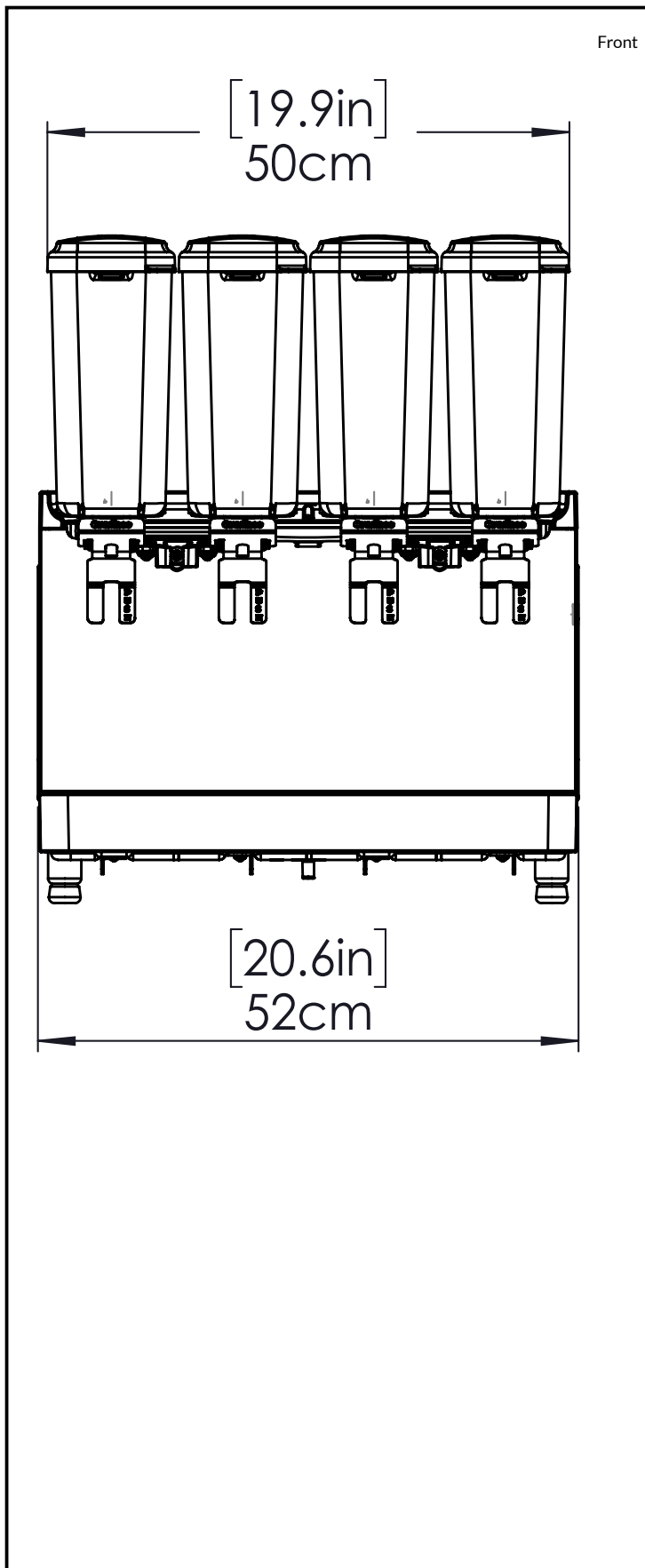

Certifications



The company reserves the right to make modifications to the products without prior notice. All information correct at time of printing.

2024.09.17